

# AIRJET<sup>®</sup>



## Chimney Lining Systems

### Gas or Propane Fired Appliances



### Table of Contents

1. <b>General Instructions and Warnings</b> U.L. and Manufacturers Specifications.....	2
2. <b>Types of Liner Systems</b> .....	3
3. <b>FLEXJET</b> Installation Instructions.....	4 - 5
4. <b>FLEXJET / “B” - Vent Combination</b> Installation Instructions.....	6
5. <b>“B” - Vent Liner</b> Installation Instructions.....	7
6. <b>Connecting FLEXJET Liner Systems to Gas Fireplaces</b> Installation Instructions.....	8
7. <b>FLEXJET in a Pre-Existing Listed “B” Vent or Metal Chimney System</b> Installation Instructions.....	8

# General Instructions

**WARNING:** Do not use any other materials and or components within the chimney other than the ones specified in the following installation instructions.

1. These instructions are for the "AirJet" / "FLEXJET" chimney liner systems only.
2. Read the following installation instructions thoroughly before installing any component of the chimney liner. If there are any problems, contact your local distributor.
3. Clean and repair the existing chimney as required. **Note: Removal of all tar glazed creosote is essential, prior to installation of the "FLEXJET" chimney liner system.** Remove and/or repair any cracked bricks, mortar or any other materials that might inhibit the installation of the "FLEXJET" chimney liner system.
4. Contact your local Building or Fire Officials about Restrictions and Installation Inspection that are required in your area.
5. The wall penetration assemblies must not be located directly behind a heating appliance.
6. The chimney liner **must not** be sized less than that specified in the appliance manufacturers instructions.
7. The standard "FLEXJET" chimney liner system kits are available in continuous Lengths of 25 ft. (762.00 cm) and 35 ft. (1066.80 cm). If necessary two lengths of liner may be connected with a single wall connector splice, but there shall be no more than (1) one connector splicer per complete chimney liner system.
8. Be sure the chimney extends to conform to applicable local and national Building codes. That is, chimneys are required to extend at least (3) three feet (91.44 cm) above the highest point where they pass through the roof of a building, and at least (2) two feet (60.96 cm) higher than any portion of the building within (10) ten feet (304.80 cm). (see illustration above)
9. "FLEXJET" is listed for use and may be installed as a liner for Gas Fired Appliances.
  - a) In a masonry chimney which has zero clearance between the chimney exterior a combustible materials.
  - b) In a listed Pre-Existing metal chimney or vent system which was properly installed, following listed clearances.
10. AirJet / FLEXJET aluminum liner systems are designed for use with Gas or Propane fired Category I equipment (as outlined in the National Fuel Gas Code - NFPA-54). This applies to both draft hood equipped and fan assisted appliances listed for use with Type-"B" vent. The following are some of the gas appliances intended for use with aluminum liners: Furnaces, Boilers, Fireplaces, Water Heaters, Clothes Dryers, Ranges, Burners. **Check appliance manufacturers instructions prior to installations.**
11. Top termination fittings for 5 1/2" (13.97 cm) diameter "FLEXJET" kits are standard 6" (15.24 cm) I.D. For bottom connector fittings use standard 6" (15.24 cm) FJB ("B" Vent Connector) or FJS (Single Wall Connector). These adjustable connectors will fit 5 1/2" (13.97 cm) diameter "FLEXJET".
12. Maintenance: In accordance with NFPA-54 all chimney and vent systems should be inspected annually before heating season. Untwist cap and inspect for any signs of corrosion or deterioration.

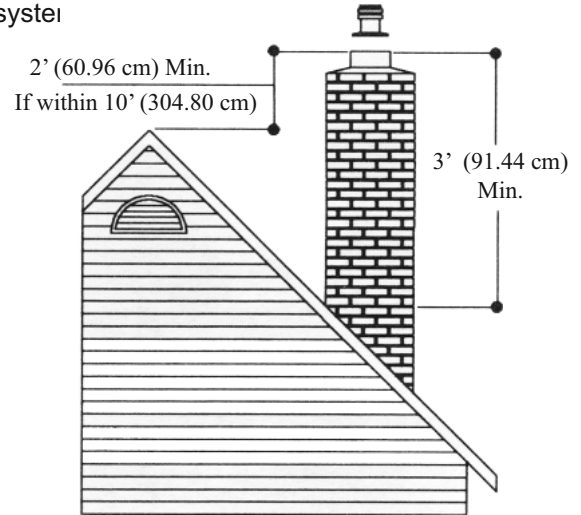

### Minimum and Maximum Clearances

"FLEXJET" Liner Dia.	Minimum Chimney Dimensions	"FLEXJET" Liner Dia.	Minimum Chimney Dimensions
3" (7.62 cm)	3 5/8" x 3 5/8" (9.208 x 9.208 cm)	7" (17.78 cm)	7 5/8" x 7 5/8" (18.405 x 18.405 cm)
4" (10.16 cm)	4 5/8" x 4 5/8" (11.748 x 11.748 cm)	8" (20.32 cm)	8 5/8" x 8 5/8" (21.908 x 21.908 cm)
5" (12.70 cm)	5 5/8" x 5 5/8" (14.288 x 14.288 cm)	10" (25.40 cm)	10 5/8" x 10 5/8" (26.025 x 26.025 cm)
5 1/2" (13.97 cm)	6 1/4" x 6 1/4" (15.875 x 15.875 cm)		
6" (15.24 cm)	6 5/8" x 6 5/8" (16.828 x 16.828 cm)		
			Max. Chimney Height: 65 ft (1981.20 cm)
			Min. Chimney Height: 10 ft (304.80 cm)
			Min. Brick Thickness: 3 1/2" (8.89 cm)

# Types of Installations for Maximizing Insulation Value and Condensation Control in Chimney Lining Systems

AirJet Type “B” - Vent and “FLEXJET” liner kits maybe used separately or in conjunction to provide maximum insulation value within the chimney for a variety of specific lining situations. Exposure of the chimney, tile liner dimensions, and whether it includes any offsets or not determines your choice of straight “FLEXJET” kits or “B” - Vent or a combination of both.

The integral male fitting on the “FLEXJET” liner allows for use either as a termination fitting, or to connect to additional lengths of standard AirJet “B” - Vent for superior insulation value with exposed systems.

The following are typical situations utilizing AirJet “B” - Vent and/or “FLEXJET” to provide maximum resistance to excessive condensation within the chimney. All liner systems should then be hooked up to the appliance(s) with “B” - Vent or single wall as required by the National Fuel Gas Code Tables.

Utilizing double wall type “B” - Vent in the chimney, and as a connector adds insulation value to any system while adding very little to either the material or installation cost.

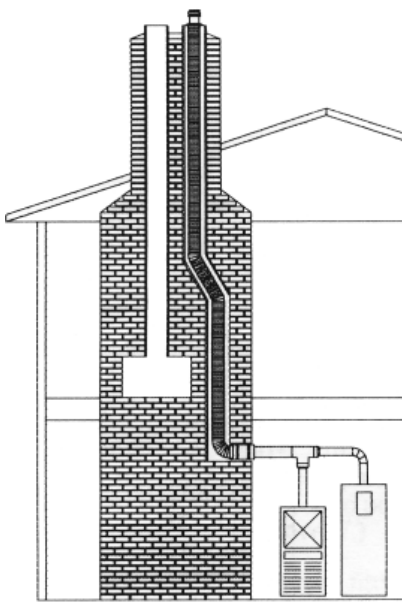

**Condition 1: GOOD  
Installation Type 1**

All “FLEXJET” System  
Generally recommended on interior systems, or where conditions such as size of flue and offsets dictate the use of flex only through the chimney.  
Meets requirements of NFPA-54

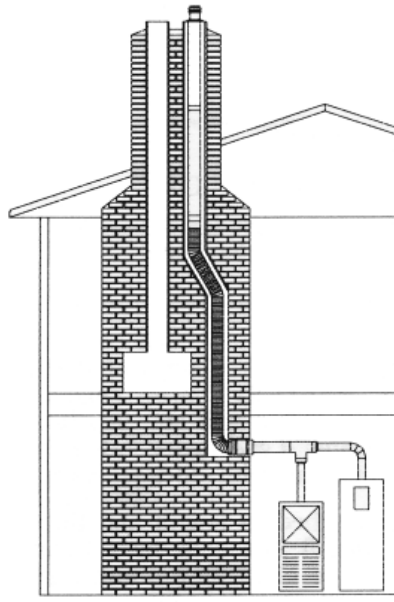

**Condition 2: BETTER  
Installation Type 2**

“FLEXJET” & “B” - Vent System  
Combination system recommended for use on exposed chimney which includes a flue offset.

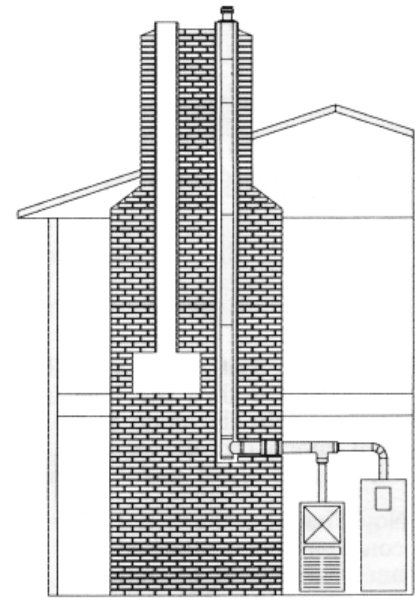

**Condition 3: BEST  
Installation Type 3**

“B” - Vent Liner System  
For exposed systems when possible. Flue must be of adequate dimensions with no offset.



## Installation Instructions for ALL FLEXJET (within chimney) System

Standard Flex-Jet Kit (FSK) Includes the following:

Available Components:

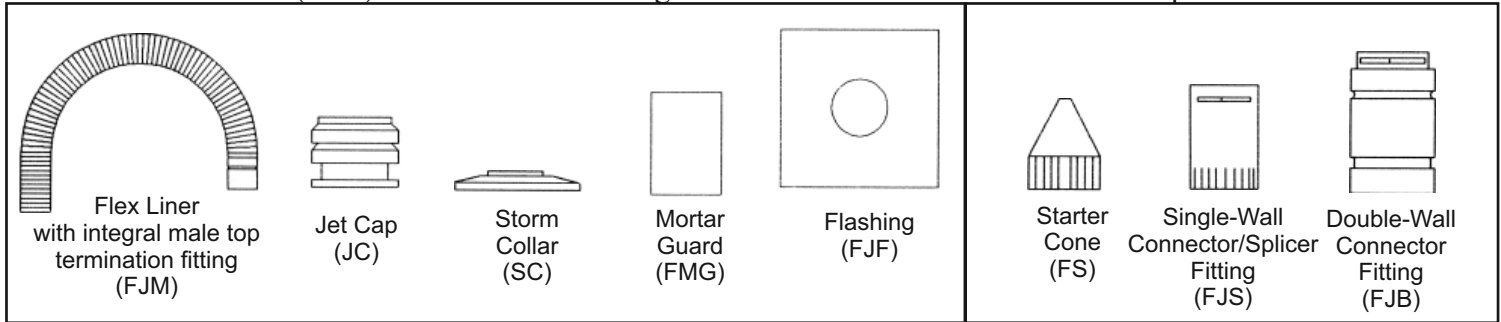

- Step 1. Read, understand and follow all the instructions thoroughly before proceeding with the installation of any components or appliances.
- Step 2. Be sure that the flue passageway is free from all obstruction that could cause problem with the installation of the "FLEXJET" liner later.
- Step 3. Layout all "FLEXJET" components and make sure that each piece listed above is accounted for.
- Step 4. At the base of the chimney where the appliance vent connector will attach to the liner, break out sufficient brick and mortar to allow the liner to exit the chimney and the mortar guard.
- Step 5. The "FLEXJET" liner has been compressed to approximately 33% of its actual length. Stretching the liner requires two (2) people wearing gloves (on level ground). Starting from the approximate middle of the length of the liner, one person holds the liner firmly while the other person stretches out the corrugations working outwards all the way towards the end of the liner. The "FLEXJET" liner should be allowed to "untwist" as you are working to the end. Repeat the process to stretch the other half of the liner.

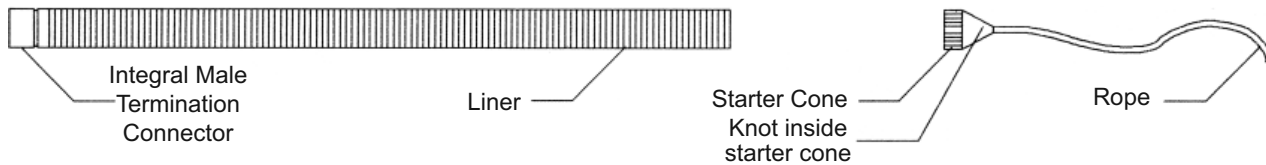

FIG. 1

- Step 6. Use a rope that is at least 12" (30.48 cm) longer than the overall length of the liner and feed one end thru the hole in the pointed end of the starter cone. Pull enough of the rope into the cone to be able to tie a knot that will not slip back thru. Then attach the starter cone to end of the liner (see FIG. 1) using either self tapping sheet metal screws or wrap the seam with duct tape.
- Step 7. Now that the "FLEXJET" liner has been stretched to length and the starter cone has been attached it is ready to be installed, usually by two (2) people, one person should be stationed on the roof at the chimney and the other at the bottom of the chimney, at the outlet end.
- Step 8. With one person on the roof, drop the rope down the chimney, feed and guide the liner down the chimney while the other at the bottom outlet pulls the rope slowly and evenly through the passageway (see FIG. 2). Stop when the bottom of the male termination/connector fitting is even with the top of the clay tile or where the flashing will be installed.

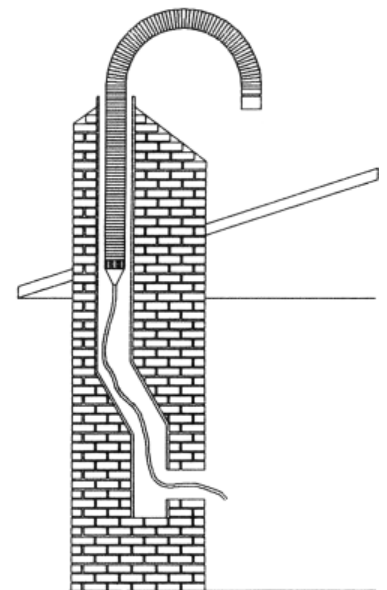
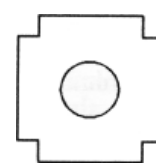

FIG. 2

**Note:** At this point the "FLEXJET" top termination/connector fitting may be used to either terminate the system ("FLEXJET" only liner system) or used to connect to additional sections of standard AirJet "B" - vent for a combination system.

Step 9. Once the "FLEXJET" liner is in place slide the flashing (flange side up) over top of the termination fitting and secure it with three (3) evenly spaced self tapping sheet metal screws thru the flange and into the fitting. On a chimney with a clay tile protruding, notch the flashing corners so that the sides can be bent over the edge of the clay tile (see FIG. 3). Place a bead of quality silicone sealant on top of the clay tile. Push the flashing down firmly on to the silicone to create a good seal. Finally bend the sides down. For chimneys with crowned and non-protruding clay tile liners, slit the flashing to conform to the crown slope (see FIG. 4). Use masonry anchors to secure the flashing. Seal all joints, open edges and all fastener holes with a quality silicone sealant.

Step 10. Apply a bead of quality silicone to bottom edge of the storm collar. Then slide the storm collar over top of the termination fitting pressing into place on to the top of the flashing (see FIG. 5). Using two (2) evenly spaced self tapping sheet metal screws, pierce through the top flange of the storm collar and into the termination fitting, then caulk the top of the storm collar. Finally snap the Jet Cap properly into place.



**FIG. 3**  
Flashing w/  
notched corners  
for clay tile

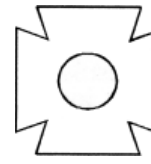

**FIG. 4**  
Flashing w/  
slit corners for  
crowned chimneys

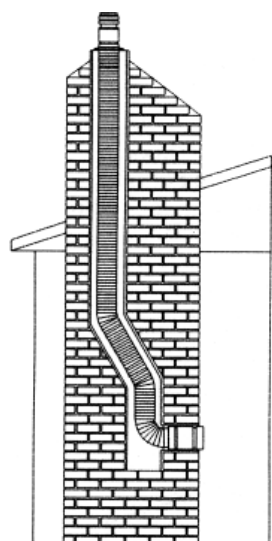

Finished Installation Shown

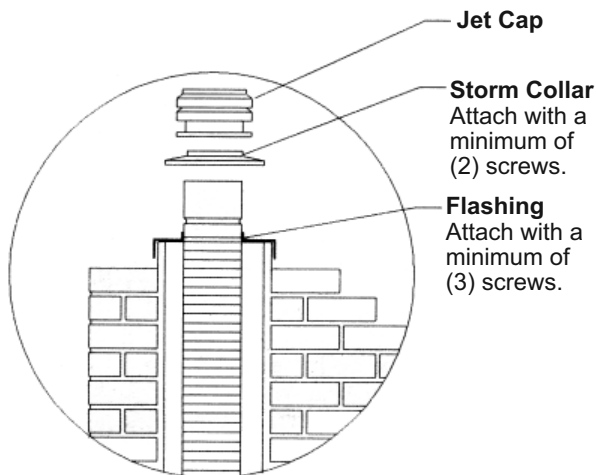

**FIG. 5**

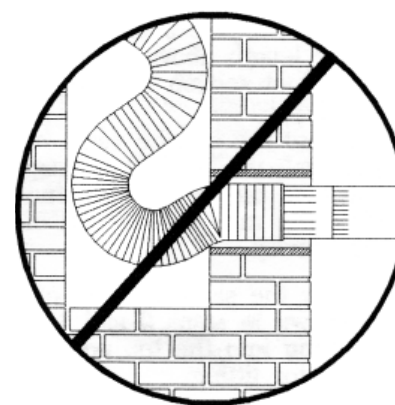

**FIG. 6**

- AVOID** - Stuffing extra Flex back into the Flue.  
 - Over compressing corrugations.  
 - Downward sloping 90's.  
 - "Wrong Way" drip fittings.

All of these conditions create the potential for condensation and corrosion.

Step 11. The assistant at the bottom outlet pulls the liner taut (without over-stretching) to eliminate excessive bends or corrugation compressions in the final installation (see FIG. 6). Trim off excess so that the liner extends approximately 1 to 2 (2.54 to 5.08 cm) inches outside the opening in the chimney. Retain starter cone for repeat use. Extra flex may also be used as a splicer piece on other jobs. Slide the mortar guard over the liner and into position in the opening of the chimney (see FIG. 7).

Step 12. Attach the appropriate fitting, preferably the "FLEXJET" drip free "B" - vent or single wall connector fitting with positive worm gear screw connection. Cement the mortar guard in place with the NFPA-211 required tag flipped outwards and visible for inspection. Slide the connector fitting back slightly so that the worm gear connection is encased just inside the mortar guard. The system is now ready for hookup as appropriate to either type "B" - vent or single wall connector to the appliance (see FIG. 7).

**NOTE: AT NO TIME SHALL THE "FLEXJET" LINER EXTEND OUTSIDE THE CHIMNEY AS A CONNECTOR TO ANY APPLIANCE.**

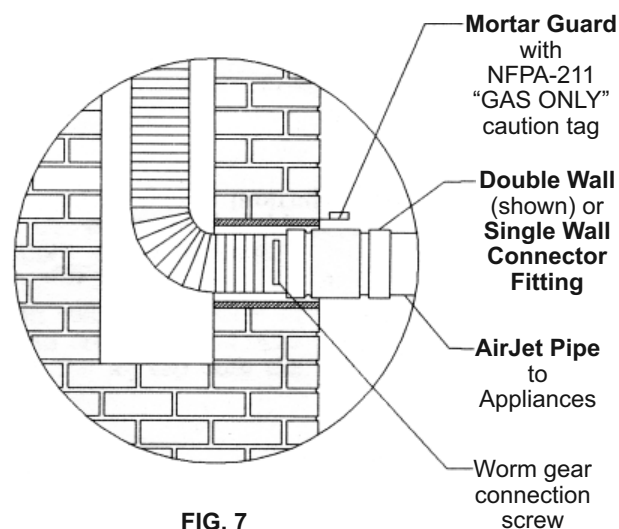

**FIG. 7**

# FLEXJET & B - VENT

## Installation Instructions for a Combination Liner (within chimney) System

The integral "FLEXJET" top termination/connector fitting allows you to use AirJet Type "B" - Vent on top of the "FLEXJET" portion. This is particularly useful for the following.

- A) In "three sides exposed" chimneys, where the coldest portion of the flue is the upper section above the offset. Using "B" - Vent down to the approximate point of the offset substantially increases the insulation value and minimizes condensation.
- B) If you inadvertently end up short of the total required length with the standard 25' (762 cm) or 35' (1066.80 cm) lengths of "FLEXJET", you can easily add "B" - Vent to finish the system without starting over.

### Follow Steps 1 through 8 of the "ALL FLEXJET SYSTEM" Instruction on page 4.

(For Combination System)

- Step 9. Figure the length down from the top of the clay tile liner to the approximate point of the offset and use standard lengths of "B" - Vent i.e. (5', 3', 2' & 1') to accommodate this portion of the system. You need enough overall length to end up with at least 5" over top of the clay tile liner (reference FIG. 5, on page 5, showing the termination of the "ALL FLEXJET SYSTEM"). However a longer length above the point where the flashing will be installed is also acceptable. Up to 2 1/2 feet if a 5 foot section is being used.
- Step 10. Line up the outside seam of the AirJet "B" - Vent and the termination fitting on the "FLEXJET" liner and push the "B" - Vent straight down for a positive "snap-lock" (there is no need to twist the connection). The person on the roof continues to feed the system down and "snap-lock" extra sections of "B" - Vent as required, while the other person at the base of the system continues to pull the rope and "FLEXJET" down through the passageway.
- Step 11. Follow the same method of attaching the flashing, storm collar and Jet Cap as shown in steps 9 and 10 on page 5 with the exception that you will be screwing into top portion of the "B" - Vent instead of the termination/connector fitting.
- Step 12. Follow step 11 and 12 shown on page 5 to finish the liner system at the base.

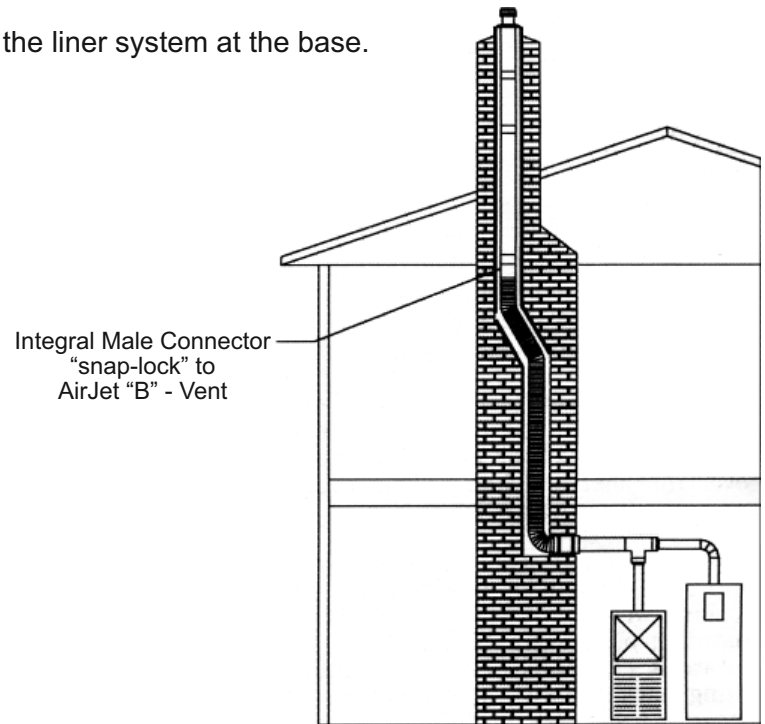

Completed Installation Shown

# B - VENT

## Installation Instructions for an All "B" - Vent (within chimney) System

- Step 1. "B" - Vent liner is normally terminated at the bottom of the masonry chimney into a "B" - Vent Tee. Therefore, to determine the length of "B" - Vent required, drop a rope or measuring device down the chimney. Measure from the top of the chimney to the top of the Tee and add at least 5" (12.70 cm) for flashing and storm collar. "B" - Vent pipe sold in standard lengths of 5, 3, 2, and 1 foot. Remember, there is 1 1/2" (3.81 cm) of joint loss with each section of "B" - Vent used. It is acceptable to terminate as much as 2 1/2 feet (76.20 cm) over the top of the chimney when using a 5 foot (152.40 cm) long section.
- Step 2. If the Tee is not supported, two (2) 3/8" (0.953 cm) diameter rods can be installed into the tile liner walls directly under the bottom of the Tee. The rods should be located at least 1" (2.54 cm) from each side of the Tee diameter for adequate support. Angle drill kit is useful for drilling necessary holes.
- Step 3. From the top of the chimney secure sections of "B" - Vent together by lining up the seams and pushing the sections together for a positive "snap-lock". While feeding down the chimney continue snapping the sections together until the sections meet at the Tee, then "snap-lock" together in the same manner as the other sections.

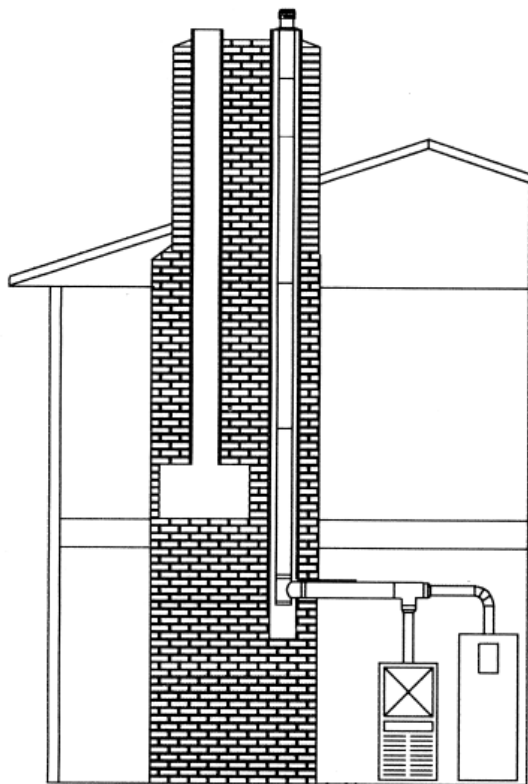

Completed Installation Shown

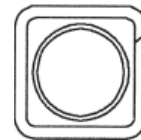

Be sure that the tile liner inside dimensions are at least 1" (2.54 cm) larger than the "B" - Vent I.D.

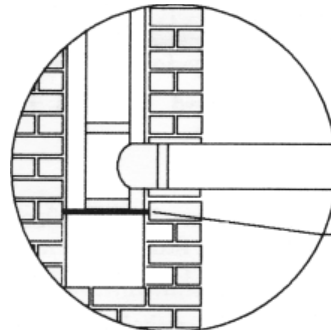

Enlarged view of the Tee

Two (2) 3/8" (0.953 cm) Diameter Support Rods place into the tile liner directly below the "TEE".

- Step 4. Slide the flashing (flange side up) over top of the "B" - Vent pipe section that is protruding out of the chimney. The flashing may be secured to the masonry liner or the crown of the chimney, by notching the corner and bending the sides over to match the contour (reference Step 9 on page 5).
- Step 5. Apply a bead of quality silicone to the bottom edge of the storm collar. Then slide the storm collar over top of the "B" - Vent pipe and press firmly onto the flashing to create a good seal. After the storm collar is in place, caulk around the top edge of collar. Then slide the Jet Cap onto the top of the "B" - Vent liner and snap into place.

## Connecting FLEXJET Liner to Gas Fireplace Inserts

Follow Steps 1 through 10 of the "ALL FLEXJET SYSTEM" Instruction on page 4.

Use MPK shown below

- Step 11. Pull the liner into the fire box. Permanently seal the damper area around the FLEXJET liner. Position the insert as close to the final location as possible, while still allowing room to work on FLEXJET liner connection.
- Step 12. Cut the FLEXJET liner to allow just enough length to hook up the Single Wall Connection fitting around the FLEXJET liner, then secure into place using the worm gear connection screw. Attach the single wall connector to the flue collar, secure into place using a minimum of three (3) evenly spaced sheet metal screws through both fittings.
- Step 13. Slide the insert into its final position. Compress the FLEXJET liner uniformly to avoid any excessive bends.

## FLEXJET Liner in a Pre-existing Listed "B" - Vent or Factory Built Metal Chimney

Remove and discard cap from existing system, Remove or disconnect existing connector at base of existing system to install "FLEXJET".

Follow Steps 1 through 8 of the "ALL FLEXJET SYSTEM" Instruction on page 4.

Use MPK shown below

- Step 9. Once the "FLEXJET" liner is in place slide the flashing (flange side up) over the top of the termination fitting. Then secure it with three (3) evenly spaced self-tapping sheet metal screws through the flange and into the fitting. Let the flashing rest on top of the existing chimney, center the "FLEXJET" flashing and trim so that it is circular in shape, approximately 1 1/2" (3.81 cm) larger in diameter than the existing chimney outside diameter. Notch and bend the overlap uniformly around the existing chimney. Use a minimum of four (4) evenly spaced self-tapping sheet metal screws through the overlap and into the existing chimney to secure in place. Seal all joints and screw heads with caulk.
- Step 10. Secure the storm collar as shown in step 10 on page 5.
- Step 11. Pull the "FLEXJET" taut from the base without overstretching. Cut any excess flex off leaving approximately 1" (2.54 cm) below the chimney base support (or "B" - Vent pipe passing through the final fire stop / support assembly) in appliance/equipment room.
- Step 12. Attach Single Wall Connector fitting to the flex, use the worm gear connector over top of the flex and even with the previous base of the chimney or vent. Reattach existing connector pipe to the connector fitting (with three (3) screws) if in a serviceable condition. Replace connector pipe if necessary.

Multi-Purpose Flex-Jet Kit (MPK) Includes the following:

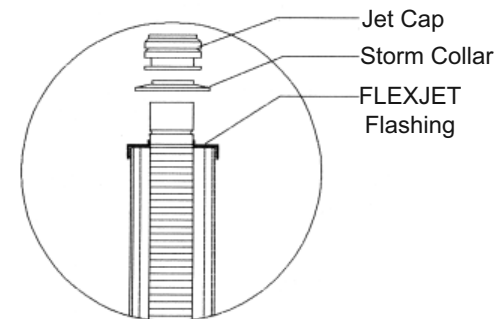
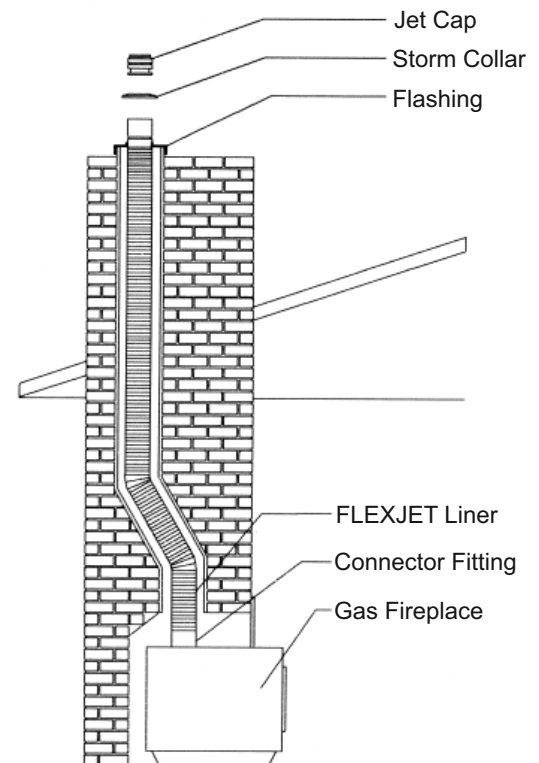
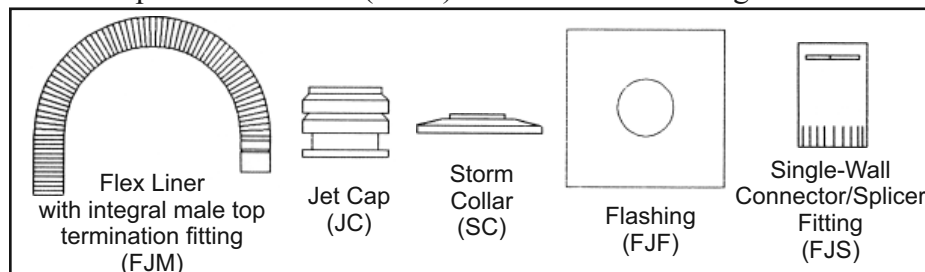

Enlarged View of Pre-existing System Cap Installation

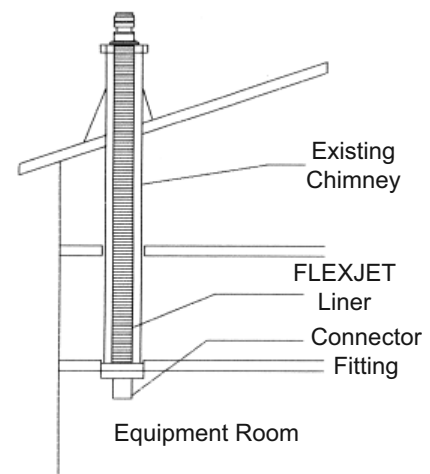

Quality and Service for over 50 years.

**AIRJET**